

# Data Sheet



Article number: 0125083

Description: Retaining ring SP72  
Spring steel

## Measures

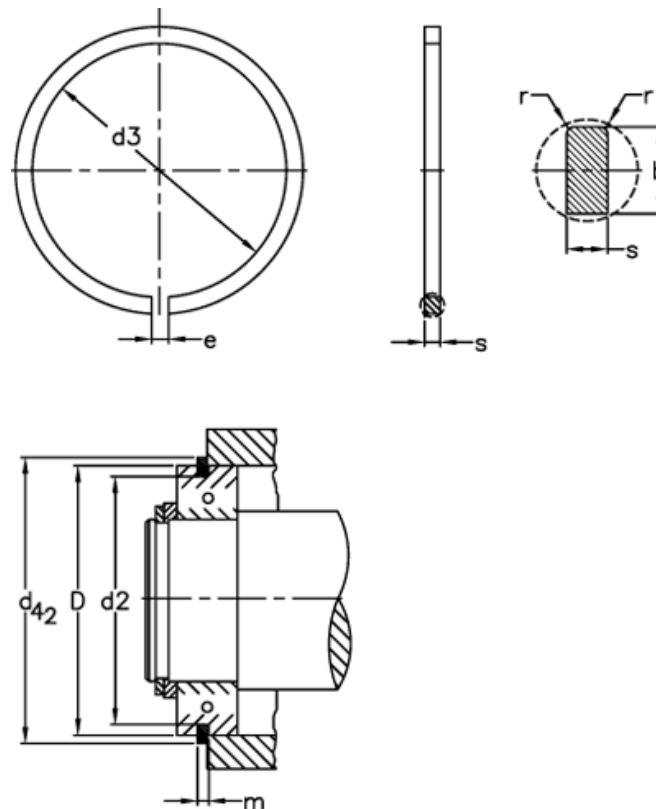

b	= 4.85	FRg kN	= 6.71	tol	= -0.15
D	= 72	FR kN	= 38.9	tol	= -0.1
d2	= 68.81	g	= 2.5	tol	= -0.50
d3	= 67.4	K kN-mm	= 71.3	tol	= 0.3
d42	= 78.6	m	= 1.90	tol	= 0.8
Description	= SP 72	n abl x 1000	= 4.0	Weight kg/1000	= 14.7
e	= 5	r min	= 0.6		
FN kN	= 59.0	s	= 1.70		